



- Programmable incremental encoder
- Compact size & rugged design
- Resolution from 1 to 16384 PPR
- Selectable Index length 90 or 180° el.
- Counting direction cw, ccw
- Push-Pull + Line Driver compatible output
- Programmable via USB cable



IQ36 • CKQ36

ENVIRONMENTAL SPECIFICATIONS

Shock:	100 g, 6 ms
Vibrations:	10 g, 5-2000 Hz
Protection:	IP67, IP65 shaft side
Operating temperature range:	-25°C +85°C (-13°F +185°F)
Storage temperature range:	-40°C +100°C (-40°F +212°F) (98% R.H. without condensation)
Option:	Protection IP69K (sealed circuits)

MECHANICAL SPECIFICATIONS

Dimensions:	see drawing
Shaft diameter:	Ø 6 mm
Hollow shaft diameter:	Ø 6 mm
Shaft loading (axial, radial):	20 N max.
Shaft rotational speed:	typ. 6000 rpm / 12000 temporary
Starting torque at 20°C:	0,1 Ncm (typical)
Bearings life:	10 ⁹ rev. min.
Electrical connections:	M12 plug or cable output 1 m (3.3 ft)
Weight:	~ 50 g (1,7 oz)
Option:	• additional cable

ELECTRICAL SPECIFICATIONS

Resolution (PPR):	programmable from 1 to 16384
Accuracy:	± 0,15°
Counting frequency:	500 kHz max.
Output circuits:	Universal output (PP+LD compatible)
Power supply:	+5V +30V
Consumption:	60 mA (typical)
Output current (each channel):	40 mA max.
Protection:	against inversion of polarity and short cut
EMC:	electro-magnetic immunity, EN 61000-4-2 EN 61000-4-4

MATERIALS

Flange:	anticorrosive, UNI EN AW-6082
Housing:	anticorrosive, UNI EN AW-6082
Bearings:	ABEC 5
Shaft:	stainless steel, non-magnetic - UNI EN 4305

ACCESSORIES

E-M12F12:	M12 12 pin mating connector
EC-M12F12-LK-T12-5:	M12 cordset with 5 m cable*
EC-M12F12-LK-T12-10:	M12 cordset with 10 m cable*
PAN/PGF:	flexible couplings
KIT IP/IQ58:	USB programming kit
EC-IP/IQ58-M12:	M12 programming cable

*not suitable for programming

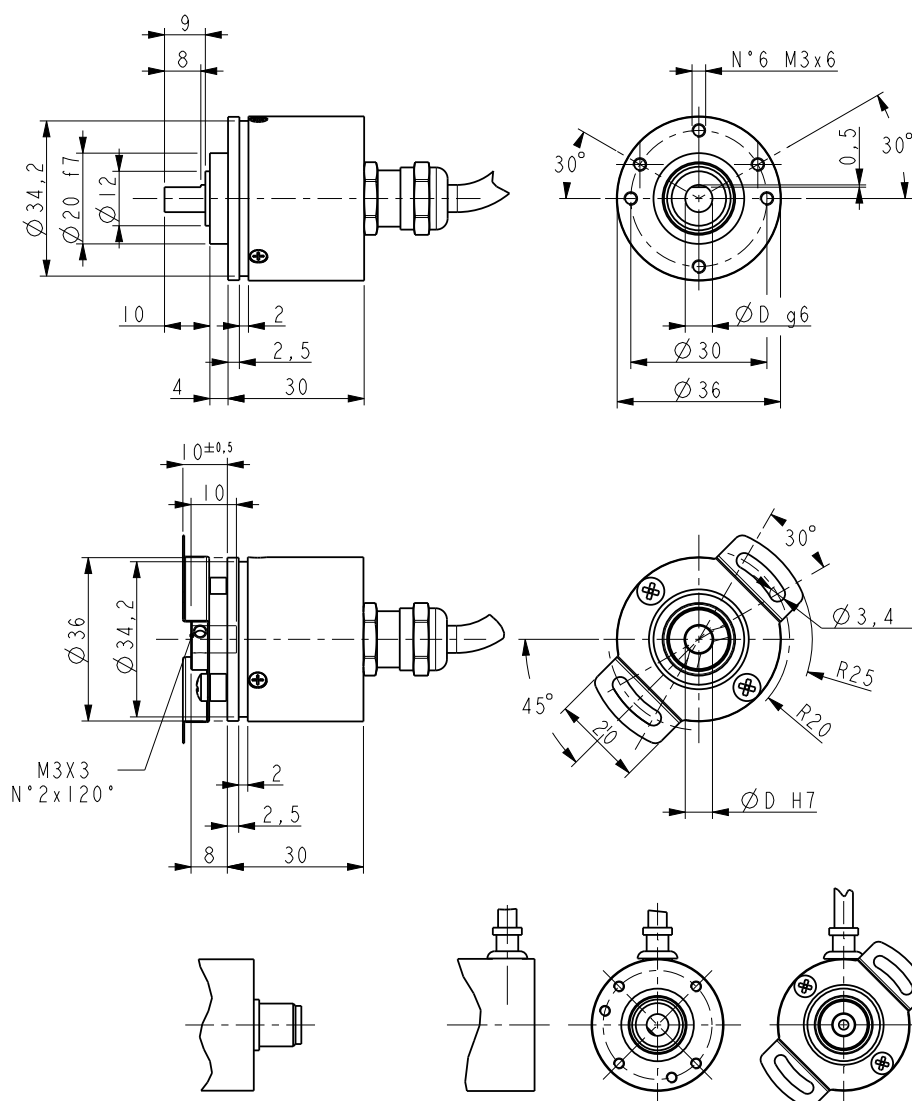

IQ36 • CKQ36

Order code

IQ36 CKQ36	-	X a	-	XXXX b	XXX c	X d	X e	X f	XX g	/Sxxx h
---------------	---	--------	---	-----------	----------	--------	--------	--------	---------	------------

a OUTPUT CIRCUITS

H = PP/LD universal circuit

b RESOLUTION (PPR)

PROG = programmable

c OUTPUT SIGNALS / CONNECTIONS

ZCW = ABO /ABO, 12 wires cable output (type T12)

ZCM = ABO /ABO, M12 12 pin plug

d SUPPLY VOLTAGE

4 = +5V ÷ +30V

e SHAFT DIAMETER

6 = 6 mm

f PROTECTION

- = IP67

J = IP69K (with sealed circuits)

g CABLE LENGTH (only with ZCW)

L1 = cable output 1 m

L2 = cable output 2 m (max. length)

RL1 = cable output 1 m radial

RL2 = cable output 2 m radial (max. length)

h CUSTOM VERSION